

Rear View

CON3

1	FAN SIGNAL PS1A
2	FAN SIGNAL PS1B

CON4

1	FAN SIGNAL PS2A
2	FAN SIGNAL PS2B

CON7

1	FAN SIGNAL PS3A
2	FAN SIGNAL PS3B

CON8

1	FAN SIGNAL PS4A
2	FAN SIGNAL PS4B

CON10

1	PS ON/OFF
2	+3.3V SENSE
3	+12V SENSE
4	+5V SENSE
5	PG SIGNAL (SYS.)

CON9

1	+5V	13	BUZZER RESET
2	PS1 GOOD LED	14	GND
3	PS2 GOOD LED	15	GND
4	PS3 GOOD LED	16	GND
5	PS4 GOOD LED	17	GND
6	PS ONE FAIL LED	18	GND
7	PS ALL GOOD LED	19	GND
8	TTL SIGNAL	20	GND
9	PS4 PG SIGNAL	21	GND
10	PS2 PG SIGNAL	22	GND
11	PS3 PG SIGNAL	23	GND
12	PS1 PG SIGNAL	24	GND

CON10:
MOLEX 22-27-2051 OR EQU.

CON9:
MOLEX 10-88-1241 OR EQU.

CON3,CON4,CON7,CON8:
MOLEX 22-28-4020 OR EQU.

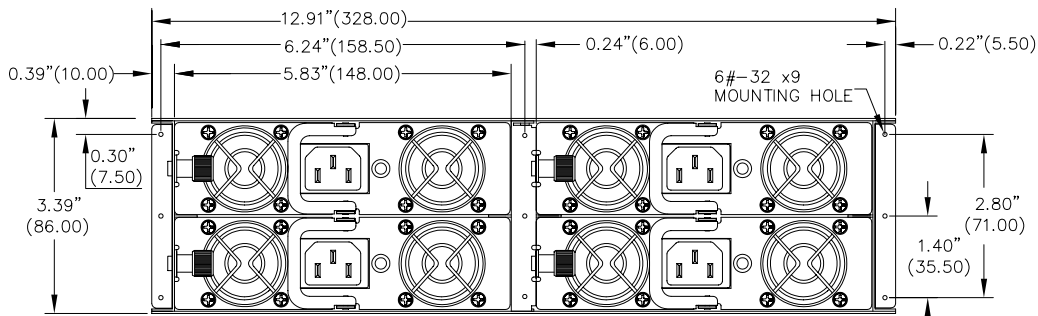
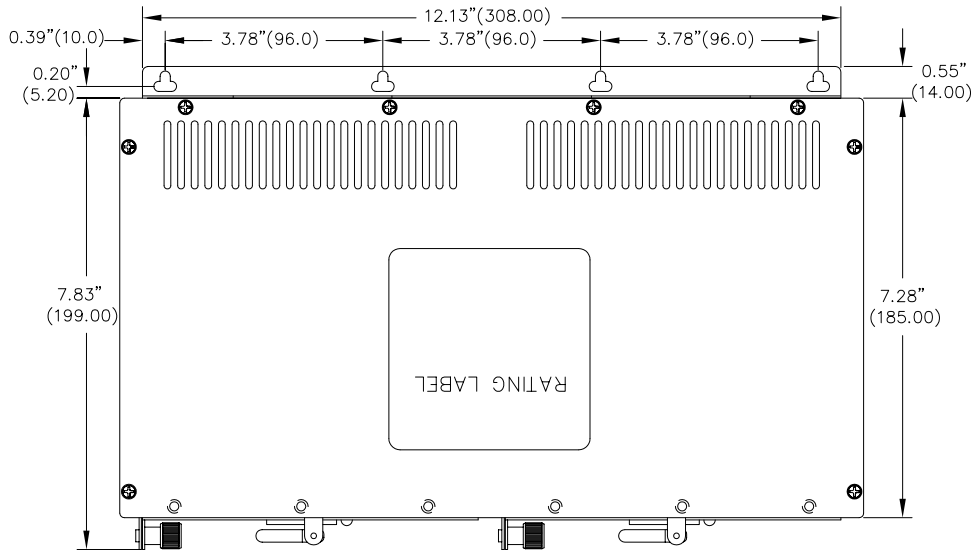

	APPROVED TUNGPO	CHECKED JASPER	DRAWING NO. M-4H-AC02	UNIT INCHES(MM)	REV. 0.1
	TITLE MINI PS2, 3+1 H TYPE, AC I/P, 910W(1200W) O/P	DESIGNED CHEFON	DRAWING JOLN	MODEL NO. PRB910(1200)MH-J4	TOLERANCES: .X = ±0.2 .XX = ±0.15